



SunPower® E-Series Commercial Solar Panels | E20-435-COM

More than 20% Efficiency

Captures more sunlight and generates more power than Conventional Panels.

High Performance

Delivers excellent performance in real world conditions, such as high temperatures, clouds and low light.^{1,2,4}

Utility grade

Optimized to maximize returns, the E-Series panel is a bankable solution for large-scale power plants.

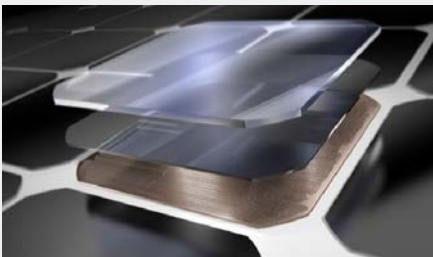

Maxeon™ Solar Cells: Fundamentally better.
Engineered for performance, designed for reliability.

Engineered for Peace of Mind

Designed to deliver consistent, trouble-free energy over a very long lifetime.^{3,4}

Designed for Reliability

The SunPower Maxeon Solar Cell is the only cell built on a solid copper foundation. Virtually impervious to the corrosion and cracking that degrade Conventional panels.³

#1 Rank in Fraunhofer durability test.⁹
100% power maintained in Atlas 25+ comprehensive Durability test.¹⁰

High Performance & Excellent Reliability

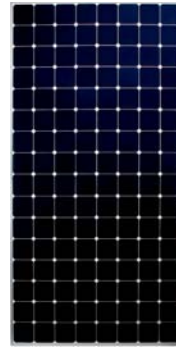

SPR-E20-435-COM



High Efficiency⁵

Generate more energy per square meter

E-Series commercial panels convert more sunlight to electricity producing 31% more power per panel,¹ and 60% more energy per square meter over 25 years.^{1,2,3}

High Energy Production⁶

Produce more energy per rated watt

More energy to power your operations. High year one performance delivers 7-9% more energy per rated watt.² This advantage increases over time, producing 20% more energy over the first 25 years to meet your needs.³

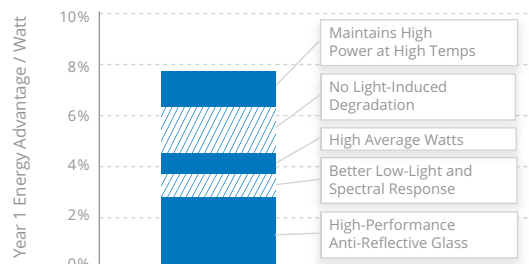
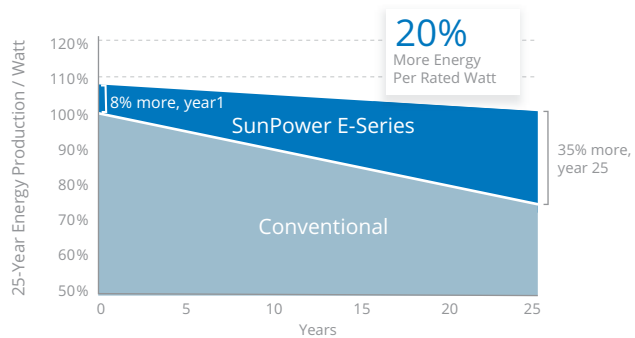



SunPower® E-Series Commercial Solar Panels | E20-435-COM

Sunpower Offers The Best Combined Power And Product Warranty

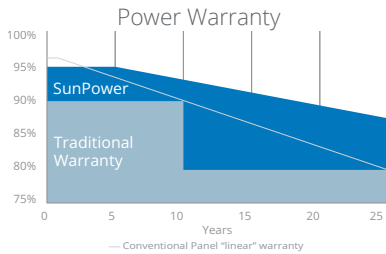

More guaranteed power: 95% for first 5 years, -0.4%/yr. to year 25.⁷

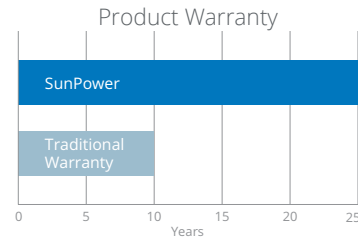

Combined Power and Product defect 25 year coverage that includes panel replacement costs.⁸

Electrical Data	SPR-E20-435-COM	SPR-E19-410-COM
	Nominal Power (P _{nom}) ¹¹	435 W
Power Tolerance	+/- 5%	+/- 5%
Avg. Panel Efficiency ¹²	20.3%	19.1%
Rated Voltage (V _{mpp})	72.9 V	72.9 V
Rated Current (I _{mpp})	5.97 A	5.62 A
Open-Circuit Voltage (V _{oc})	85.6 V	85.3 V
Short-Circuit Current (I _{sc})	6.43 A	6.01 A
Max. System Voltage	1000 V IEC & 1000 V UL	
Maximum Series Fuse	15 A	
Power Temp Coef.	-0.38% / °C	
Voltage Temp Coef.	-235.5 mV / °C	
Current Temp Coef.	3.5 mA / °C	

Tests And Certifications	
Standard tests ¹³	IEC 61215, IEC 61730, UL1703 (Type 2 Fire Rating)
Quality Certs	ISO 9001:2008, ISO 14001:2004
EHS Compliance	RoHS, OHSAS 18001:2007, lead free, PV Cycle, REACH SVHC-163
Sustainability	Cradle to Cradle
Ammonia Test	IEC 62716
Desert Test	10.1109/PVSC.2013.6744437
Salt Spray Test	IEC 61701 (maximum severity)
PID Test	Potential-Induced Degradation free: 1000 V ⁹
Available listings	TUV, UL, CSA, CEC, FSEC

Operating Condition And Mechanical Data	
Temperature	- 40° C to +85° C
Impact Resistance	25mm diameter hail at 23 m/s
Appearance	Class B
Solar Cells	128 Monocrystalline Maxeon Gen II
Tempered Glass	High transmission tempered Anti-Reflective
Junction Box	IP-65 Rated, Tyco (PV4)
Weight	25,4 kg
Max. Load	Wind: 2400 Pa, 244 kg/m ² front & back Snow: 5400 Pa, 550 kg/m ² front
Frame	Class 2 silver anodised

REFERENCES:

- All comparisons are SPR-E20-327 vs. a representative conventional panel: 250W, approx. 1.6 m², 15.3% efficiency.
- Typically 7-9% more energy per watt, BEW/DNV Engineering "SunPower Yield Report," Jan 2013.
- SunPower 0.25%/yr degradation vs. 1.0%/yr conv. panel. Campeau, Z. et al. "SunPower Module Degradation Rate," SunPower white paper, Feb 2013; Jordan, Dirk "SunPower Test Report," NREL, Q1-2015.
- "SunPower Module 40-Year Useful Life" SunPower white paper, May 2015. Useful life is 99 out of 100 panels operating at more than 70% of rated power.
- Second highest, after SunPower X-Series, of over 3,200 silicon solar panels, Photon Module Survey, Feb 2014.
- 8% more energy than the average of the top 10 panel companies tested in 2012 (151 panels, 102 companies), Photon International, Feb 2013.
- Compared with the top 15 manufacturers. SunPower Warranty Review, May 2015.
- Some restrictions and exclusions may apply. See warranty for details..
- 5 of top 8 panel manufacturers tested in 2013 report, 3 additional panels in 2014. Ferrara, C., et al. "Fraunhofer PV Durability Initiative for Solar Modules: Part 2". Photovoltaics International, 2014.
- Compared with the non-stress-tested control panel. Atlas 25+ Durability test report, Feb 2013.
- Standard Test Conditions (1000 W/m² irradiance, AM 1.5, 25° C). NREL calibration Standard: SOMS current, LACCS FF and Voltage.
- Based on average of measured power values during production.
- Type 2 fire rating per UL1703:2013, Class C fire rating per UL1703:2002.

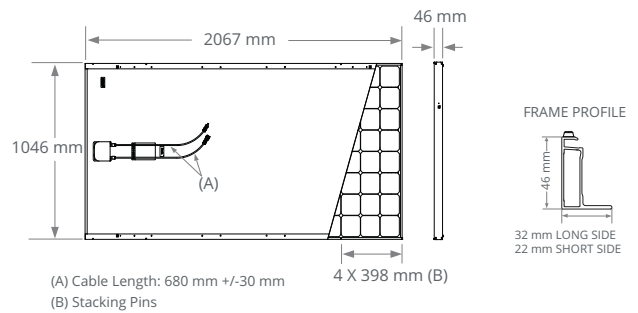

Please read the safety and installation guide.

See www.sunpower.com/facts for more reference information.
For more details, see extended datasheet: www.sunpowercorp.co.uk/datasheets.

Document # 505819 Rev D /A4_UK_AUS